

## Index

|   |    |
|---|----|
| Index.....  | 1  |
| 1. Index.....   | 2  |
| 2. Specifications.....                                | 3  |
| 2.1、 Display.....                                     | 3  |
| 2.2、 Features and Specifications of axis control..... | 3  |
| 2.3、 Environment temperature.....                     | 3  |
| 3. Introduction to Control Panel.....                 | 4  |
| 3.1、 Control Panel.....                               | 4  |
| 3.2、 System introduction.....                         | 4  |
| 4. Auxiliary Functions.....                           | 6  |
| 4.1 Auxiliary functions interface.....                | 6  |
| 4.2 Configuration.....                                | 7  |
| 4.3 English/Chinese language selection.....           | 10 |
| 4.4 Metric/imperial system switch.....                | 10 |
| 4.5 Test Interface.....                               | 11 |
| 5. Process Interface.....                             | 16 |
| 5.1 Interface display.....                            | 16 |
| 5.2 Terms.....  | 16 |
| 5.3 Operation.....                                    | 16 |
| 5.4 Notes.....  | 17 |
| 5.5 Sample.....                                       | 17 |
| 6. Continuous Test.....                               | 18 |
| 6.1 How to enter the interface.....                   | 18 |
| 6.2 Operation.....                                    | 19 |
| 6.3 Note.....   | 19 |
| 7. Machine parameters.....                            | 19 |
| 7.1 Machine parameters interface.....                 | 19 |
| 7.2 Terms.....  | 20 |
| 7.3 Configuration.....                                | 20 |
| 8. Appendix.....                                      | 21 |
| 8.1 Encoder Interface Connection Table.....           | 21 |
| 8.2 J4、 J3、 J7interface input/output table.....       | 22 |
| 8.3 System interface chart.....                       | 23 |
| 8.4 Trouble-shooting.....                             | 24 |

## 1. Product Introduction

The Wonder Bender Digital System has combined all the cutting-edge technologies and is tailor-made for Chinese customers.

The product, built with solid alloy, is elegant, easy to operate, efficient and stable.

Features:

- 1、 64\*128 LCD display;
- 2、 High-end blue monitor;
- 3、 High-definition Chinese display;
- 4、 English/Chinese dual language support;
- 5、 Digitalized display of X/Y axis;
- 6、 Accurate control;
- 7、 Self-diagnosis of exterior switch;
- 8、 Smart alarm system;
- 9、 Optional exterior switches;
- 10、 Single-way positioning.

## 2. Specifications

### 2.1、 Display

64\*128 LCD blue/white display

### 2.2、 Features and Specifications of axis control

#### 1、 The system controls two axes (X、 Y):

Axis X: controls the forward/backward movement of back gauge;

Axis Y: controls the up/down stroke of oil cylinder

#### 2、 Power supply:

Input voltage: DC24V  $\pm$  2%

Maximum current: 5A /6A

### 2.3、 Environment temperature

Working environment temperature: 0 ~ 45℃

Storage environment temperature: 0 ~ 70℃

### 3. Introduction to Control Panel

#### 3.1、Control Panel



#### 3.2、System introduction

##### 1、 Display window:

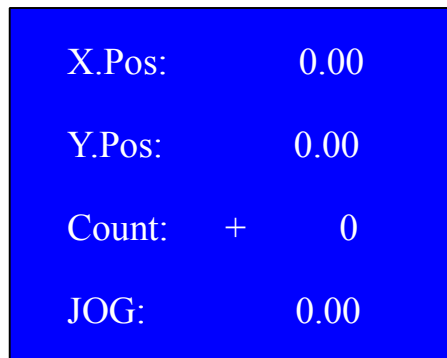

##### 2、 Key introduction:

###### (1) . Function keys:



-----clears the current and previous values;



-----confirm and save;



-----quit and back;



-----move cursor up;



-----move cursor down;



-----plus/slow backward;



-----minus/slow forward.

(2). Status switch keys:



-----press the key to start system (green);



-----press the key to stop;  
enter auxiliary functions interface (red)

(3). Digital input keys:

“0 ~ 9” -----Enter 10 digits;



-----the point key;

**3. Indicators:**

System status indicators:



-----indicating “operating” ;



-----indicating “stop” .

## 4. Auxiliary Functions



### 4.1 Auxiliary functions interface

(1)、How to enter:

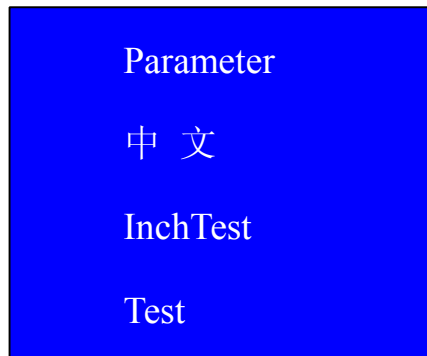
hold the stop key  to enter the auxiliary functions interface, as shown below:





(2)、Interface introduction

Press  or  to switch between lines and choose the function you wish to set:

The words “Auxiliary functions” is shown on the left of the LCD screen;

Line 1: Parameter (configuration), press  to enter;

Line 2: displaying Chinese or English, press  to switch between Chinese and English;



Line 3: press  switch between metric and imperial units;

Line 4: press  to enter testing interface;

### 4.2 Configuration

1、How to enter the interface

When the cursor stays on the first line of “auxiliary

functions”, press  to start parameter setting, as shown below; enter the next page through  or  --- set parameters for “Axis Y” .

|           |      |
|-----------|------|
| FLimit:   | 0.00 |
| BLimit:   | 0.00 |
| XMolecul: | 1    |
| Xdenomin: | 1    |

|            |      |
|------------|------|
| Ulimit:    | 0.00 |
| Dlimit:    | 0.00 |
| YMolecul : | 1    |
| YDenomin:  | 1    |

## 2、Interface introduction



(1) . First page:

Line 1: front limit, the zero position;

Line 2: back limit, the backward movement limit of gauge motor;

Line 3: X molecule, in direct proportion to line 4;

Line 4: X denominator, in inverse proportion to line 3;

(2) . Move the cursor to Page 2 by pressing  or .

Line 1: ULimit, the limit for the upward movement of oil cylinder;

Line 2: DLimit, the limit for the downward movement of oil cylinder;

Line 3: Y molecule, in direct proportion to line 4;

Line 4: Y denominator, in inverse proportion to line 3.

## 3、Terms

“FLimit”: the minimum limit between the back gauge and shears blade;

“BLimit”: the maximum limit between the back gauge and shears

blade;

“XMolecul”: molecule, in direct proportion to denominator in  
line 4;

“XDenomin” :denominator, in inverse proportion to molecule in  
line3.



“ULimit”: the limit for the upward movement of oil cylinder;

“DLimit”: the limit for the downward movement of oil cylinder;

“YMolecul”: molecule, in direct proportion to denominator in  
line 4;

“YDenomin” :denominator, in inverse proportion to molecule in  
line3.

#### 4、 Configuration

Press  or  to switch between lines and choose the parameter you wish to change;

How to change: move the cursor to the target parameter, press  to clear the current value and input the new value with the digit keys (0~9).

#### 5、 Molecule/denominator calculation

1. X molecule/denominator formula:

Molecule/denominator=screw lead\*100/encoder line amount

For example, the screw lead is 10mm, while the encoder has 400 lines

Molecule/denominator=10\*100/400=5/2

The result is 5/2, 5 being the molecule and 12the denominator.

Input 5 to “XMolecul” and 2 to “XDenomin” .

2. Y molecule/denominator formula:

Molecule/denominator=cylinder movement per rotation \*100/encoder  
line amount

For example, the cylinder movement is 0.2mm, while the encoder has 400 lines

Molecule/denominator=0.2\*100/400=1/20



The result is 1/20, 1 being the molecule and 20 the



denominator.

Input 1 to “YMolecul” and 20 to “YDenomin”.

## 6、 Save setting

After configuration, press  to confirm and the system will notify: “save changes”, then press  and the system will require to enter the three-digit password (147), finish saving and return to the parameter setting interface.

Press  to ignore changes.

## 4.3 Metric/imperial system switch



When the cursor is on the third line, press  to switch between metric units and imperial units.

Note: this function is only available in exported machines.

## 4.4 Test Interface

### 1、 Interface Introduction

#### 1. Operation



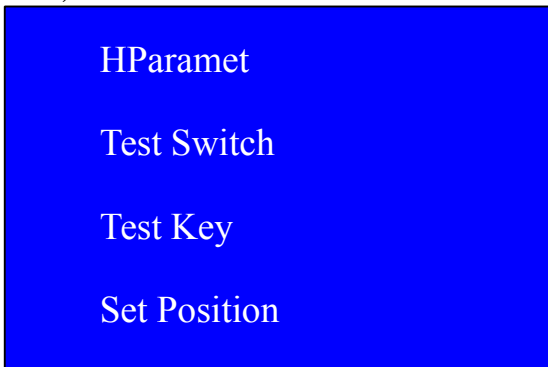

Press  or  to move the cursor to “test” , and press

 to enter the interface, as shown below:





HParamet  
Test Switch  
Test Key  
Set Position

#### 2. Interface display

- 1、Line one: press  to enter “HParamet” interface;
- 2、Line two: press  to enter test switch interface;
- 3、Line three: press  to enter test key interface;
- 4、Line four: press  to set position.

## 2、HParameter



### 1. Operation:

Press  or  to move the cursor to “HParameter”, then press , input a three-digit password (258) as hinted and enter the interface, as shown below:

|         |      |
|---------|------|
| Hold.T: | 0.00 |
| Push.T: | 0.00 |
| H.X.T:  | 0.00 |

### 2. Configuration

Move the cursor to the parameter you wish to change, press  to clear the current value, and input new value with digit keys (0~9).

After configuration, press  to save settings, press  again to confirm and the system returns to the previous page.

Press  to ignore changes and return to the previous

page.

### 3、Test switch

(1). Operation:

Move the cursor to “test switch” through  or



, then press  to enter the “test switch”

interface, as shown below:

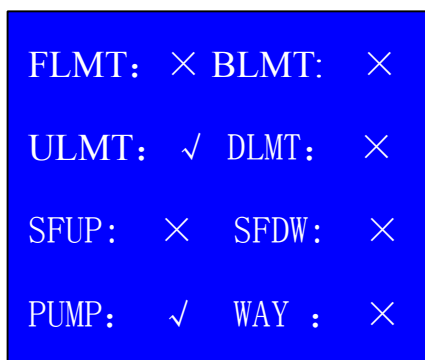

(2). Terms

FLMT: the front limit of back gauge;

BLMT: the back limit of back gauge;

ULMT: the up limit of slide;

DLMT: the down limit of slide

SFUP: foot pedal switch up

SFDW: foot pedal switch down

pump: pump motor control.



SWAY: switch between jog and single-step

(3). Test and Diagnosis

Turn the stroke switch, “√” and “×” signals shall appear on the screen; if not, please refer to appendix “ Trouble-shooting” .

### 4、Test Key

(1). Operation

Move the cursor to “test key” through  or , and



press  to enter the “test key” interface. Each key corresponds to a value, as shown below:

| Key | Value | Key | Value | Key | Value |
|-----|-------|-----|-------|-----|-------|
| 0   | 00    | 7   | 07    | OK  | 18    |
| 1   | 01    | 8   | 08    | ⇧   | 16    |
| 2   | 02    | 9   | 09    | +   | 11    |
| 3   | 03    | /// | 1D    | -   | 12    |
| 4   | 04    | ◎   | 1E    | ⇩   | 17    |
| 5   | 05    | Φ   | 1F    | ESC | 19    |
| 6   | 06    | .   | 15    |     |       |

(2)、After testing, press  twice to quit “test key” interface.

## 5、 Set position

(1) .Operation

Move the cursor to “set position” through  or ,  
press  to enter the “set position” interface. Enter a three-digit password (258) as required, and the below screen appears:

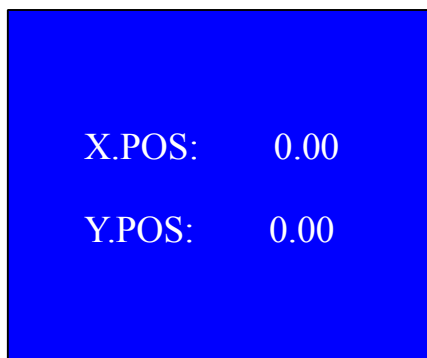







(2) .Terms

X. POS: the current position of back gauge-current value;

Y.POS: the current value of slide or cylinder movement

(3).Set parameters

Press  to delete the “X.POS” value and enter the new value with digit keys; press  or  to move the cursor to “Y.POS” , press  the “Y.POS” value and enter the new value with digit keys; Press  to save, press  again to confirm.

Press  to quit the current page to finish saving or ignore changes.

## 5. Process Interface

### 5.1 Interface display

|          |      |
|----------|------|
| X.Pos:   | 0.00 |
| Y .Pos:  | 0.00 |
| Count: + | 0    |
| JOG:     | 0.00 |

### 5.2 Terms

“X. POS”: the gap between back gauge and upper blade;



“Y.POS”: the gap between the slide and bench

“Count”: Enter the total number of bends, which will decrease after each bend.

“Way”: Switch between jog and one-step.

### 5.3 Operation

1. Make sure that both the upper and lower dies are well-positioned;



2. Press  or  to move the cursor to “X. POS”;



3. Press  to clear the “X. POS” value;

4. enter the target position of the back gauge with digit keys;

5. Press  to confirm;

6. Press  and the system starts automatic positioning; will stop at the target position;

7. Press  or  to move the cursor to “Y. POS” when the back gauge is in place;

8. Press  to clear the “Y.POS” value;
9. Input the target position of the slide with digit keys;
10. Press  to confirm;
11. Press  and the system starts automatic positioning; will stop at the target position;
12. Start bending.





#### 5.4 Notes

1. The above operation is for a single part; to bend sheets of different sizes, please repeat the above steps;
2. If the machine fail to achieve the target position after several attempts, please adjust manually.

#### 5.5 Sample

To bend a sheet to 100mm wide, bending angle 90° , please follow these steps;

1. Adjust upper and lower dies to set the bending angle to 90° ;

2. Press  or  to move the cursor to “X.POS”;
3. Press  to clear the “X.POS” value
4. enter the target value 100 with digit keys;
- 5 Press  to confirm;
6. Press  and the system starts automatic positioning; will stop at the target position;
7. No need to change “Y.POS” since the bending angle is already set
8. Start bending.

## 6. Continuous Test

### 6.1 How to enter the interface

Hold  to start continuous test, as shown below:

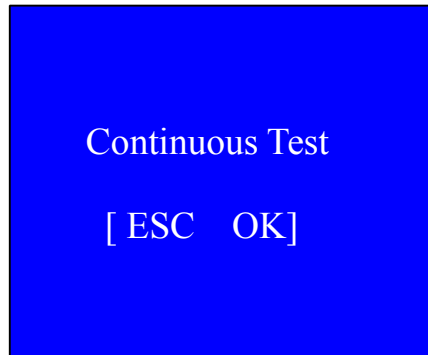

### 6.2 Operation

Press  and input a three-digit password (159) as required, then the screen will display: “continuous test” .

Press  to quit “continuous test” and return to process interface.

### 6.3 Note

If the oil pump is started already, the pump indicator will be on; otherwise, the system will indicate “pump”.

The slide should be at up limit. Only when the two conditions are met will the system starts to work, otherwise an error message will appear at the left bottom corner of the screen.



## 7. Machine parameters



### 7.1 Machine parameters interface

#### 1、Interface display

|           |      |
|-----------|------|
| XDistanc: | 0.00 |
| Xtoleran: | 0.00 |
| X.Time:   | 0.00 |
| XForword: | +    |

|           |      |
|-----------|------|
| YDistanc: | 0.00 |
| Ytoleran: | 0.00 |
| Y.Time:   | 0.00 |
| YForword: | +    |

#### 2、Operation

Hold the delete key  to switch power on, until the above screen appears. Press  or  to move the cursor to turn pages.

### 7.2 Terms

XDistance: travel distance of axis X;

XToleran: tolerance of axis X; the smaller the value, the more precision required;

XTime: intervals between standard and reverse rotation of axis X

XForward: direction of axis X count

YDistance: travel distance of axis Y;



YToleran: tolerance of axis Y



YTime: intervals between standard and reverse rotation of axis Y

YForward: direction of axis Y count

## 7.3 Configuration

### 1. Operation

Press  or  to move the cursor to the target; press  to clear and input new numbers with the digit key;

Always press  or  to change the “axis count” direction.

### 2. Save setting

Press  to save settings, and input a three-digit password (147) as required; the system will return to “machine parameters”.

Press  to quit the current interface to finish saving or ignore changes

## 8. Appendix

### 8.1 Encoder Interface Connection Table

#### 1、J1 encoder interface table

| (J1) interface no. | X axis encoder interface | Color  |
|--------------------|--------------------------|--------|
| 1                  | A                        | red    |
| 2                  | B                        | Green  |
| 3                  | Z                        | Yellow |
| 4                  | 0V                       | Black  |
| 5                  | +5V                      | White  |
| 6                  | /A                       | Pink   |
| 7                  | /B                       | Blue   |
| 8                  | /Z                       | Orange |
| 9                  | Shield                   | Shield |

Notes : 1.encoder output mode: long-line driver L (AM26LS31);  
2. The color of lines may change.

#### 2、J2 encoder interface table

| (J2) interface no. | X axis encoder interface | color  |
|--------------------|--------------------------|--------|
| 1                  | A                        | Red    |
| 2                  | B                        | Green  |
| 3                  | Z                        | Yellow |
| 4                  | 0V                       | Black  |
| 5                  | +5V                      | White  |
| 6                  | /A                       | Pink   |
| 7                  | /B                       | Blue   |
| 8                  | /Z                       | Orange |
| 9                  | Shield                   | Shield |

Notes : 1.encoder output mode: long-line driver L (AM26LS31);  
2. The color of lines may change.

## 8.2 J4、J3、J7 interface input/output table

### 1、J4 Input signal table

| J4 | Signal      |
|----|-------------|
| 1  | 0V          |
| 2  |             |
| 3  | Front limit |
| 4  | Back limit  |
| 5  | Up limit    |
| 6  | Down limit  |
| 7  | SFUP        |
| 8  | SFDW        |
| 9  | Pump        |
| 10 | way         |

### 2、J3 Output signal table

| J3 | Signal   |
|----|----------|
| 10 | KA3      |
| 9  | KA2      |
| 8  | KA1      |
| 7  | Downward |
| 6  | Upward   |
| 5  | Backward |
| 4  | Forward  |
| 3  | 0V       |
| 2  |          |
| 1  |          |

### 3、J7 input signal table

| Interface no. | Signal |
|---------------|--------|
| 1             | 24V    |
| 2             | 0V     |
| 3             | 0V     |
| 4             | 24V    |

### 8.3 System interface chart

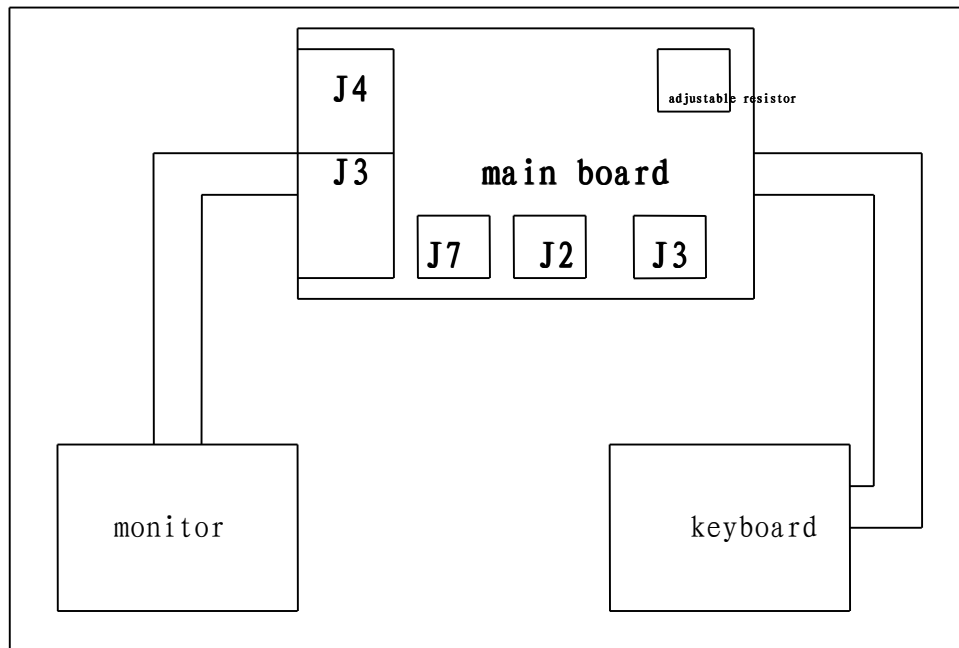

### 8.4 Trouble-shooting

|                           |   |
|---------------------------|---|
| Back gauge at back limit  | Check whether the limit switch is at the “on” (NO) position, or the front limit value is too large (current value >back limit value), or the limit switch is damaged.   |
| Back gauge at front limit | Check whether the limit switch is at the “on” (NO) position, or the front limit value is too large (current value < front limit value), or the limit switch is damaged. |
| Back gauge at up limit    | Check whether the limit switch is at the “on” (NO) position, whether the limit switch is damaged or the up limit value is too small (current value >up limit value)     |

|                          |  |
|--------------------------|--|
| Flickering screen        | Check whether the line is loose, power supply is normal, or there's any electric interference.   |
| Back gauge at down limit | Check whether the limit switch is at the “on” (NO) position, whether the limit switch is damaged or the down limit value is too small (current value < down limit value) |
| SWSF                     | Check pedal switch connection; whether system input is normal.   |
| Pump                     | Check pump control circuits, AC contractor and system output.  |

Shall other problems occur, please contact the local dealer or Shenzhen Wonder Control Technology Co., Ltd.

Shenzhen Wonder Control Technology Co., Ltd.  
Wuxi Wonder Control Technology Co., Ltd.  
Service Hotline: 0510-85898600/83729992